

# Operating instructions

Wine storage cabinet

Read the operating instructions before switching on for the first time

Page 6

**GB**

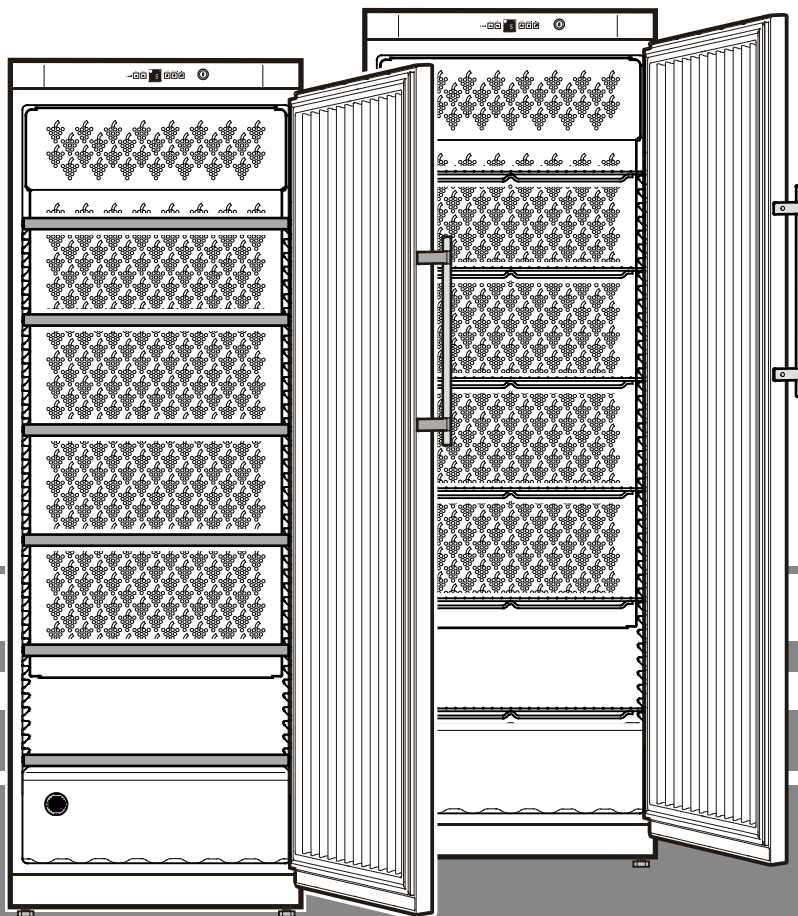

**7081 203-01**

WK/GWK

**LIEBHERR**

## Disposal notes

The appliance contains some reusable materials and should be disposed of properly - not simply with unsorted household refuse. Appliances which are no longer needed must be disposed of in a professional and appropriate way, in accordance with the current local regulations and laws.



When disposing of the appliance, ensure that the refrigeration circuit is not damaged to prevent uncontrolled escape of the refrigerant it contains (data on type plate) and oil.

- Disable the appliance.
- Pull out the plug.
- Cut through the connecting cable.

## ! WARNING

Danger of suffocation due to packing material and plastic film! Do not allow children to play with packing material. Take the packing material to an official collecting point.

## Range of appliance use

The appliance is suitable solely for storing wine in a domestic environment or similar. This includes use in, for example

- in staff kitchenettes, bed and breakfast establishments,
- by guests in country homes, hotels, motels and other forms of accommodation,
- in catering and similar services in the wholesale trade.

Use the appliance solely as is customary within a domestic environment. All other types of use are inadmissible. The appliance is not suitable for storing and cooling medicines, blood plasma, laboratory preparations or similar substances and products covered by the 2007/47/EC Medical Devices Directive. Misuse of the appliance can result in the stored products suffering harm or perishing. Furthermore, the appliance is not suitable for operation in potentially explosive atmospheres.

## Description of the appliance

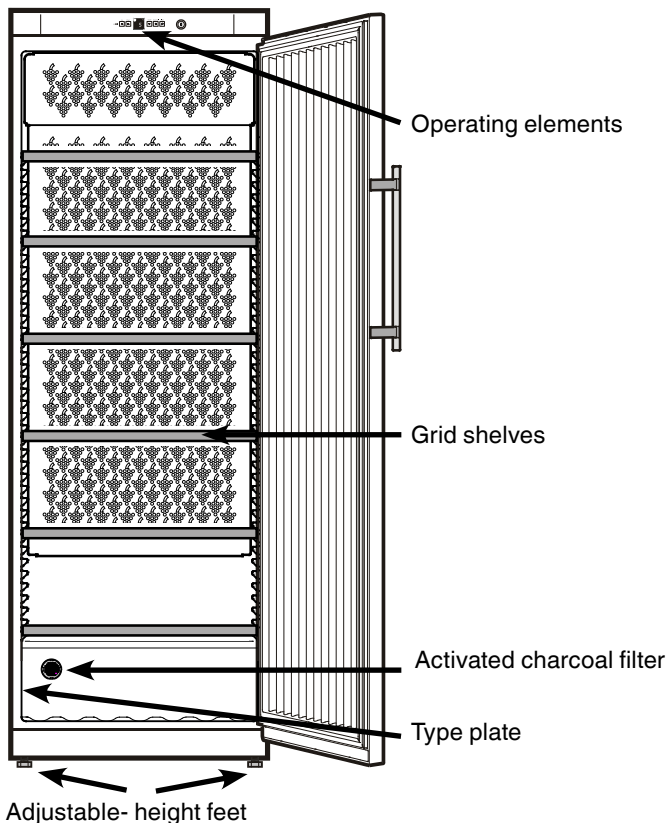

## Safety instructions and warnings

- To prevent injury or damage to the unit, the appliance should be unpacked and set up by two people.
- In the event that the appliance is damaged on delivery, contact the supplier immediately before connecting to the mains.
- To guarantee safe operation, ensure that the appliance is set up and connected as described in these operating instructions.
- Disconnect the appliance from the mains if any fault occurs. Pull out the plug, switch off or remove the fuse.
- When disconnecting the appliance, pull on the plug, not on the cable.
- Any repairs and work on the appliance should only be carried out by the customer service department, as unauthorised work could prove highly dangerous for the user. The same applies to changing the mains power cable.
- Do not allow naked flames or ignition sources to enter the appliance. When transporting and cleaning the appliance ensure that the refrigerant circuit is not damaged. In the event of damage, make sure that there are no ignition sources nearby and keep the room well ventilated.
- Do not stand on the plinth, drawers or doors or use them to support anything else.
- This appliance can be used by children of 8 years old and over, and also by persons with restricted physical, sensory or mental capacity or lack of experience and knowledge, if they are supervised or have been instructed on safe use of the appliance and understand the resulting risks. Children must not be allowed to play with the appliance. Cleaning and user maintenance must not be carried out by children without supervision.
- Avoid prolonged skin contact with cold surfaces or chilled/frozen food. This could cause pain, numbness and frostbite. In the case of prolonged skin contact, protective measures should be taken, e.g. gloves should be worn.
- Do not consume food which has been stored for too long, as it could cause food poisoning.
- Do not store explosives or sprays using combustible propellants such as butane, propane, pentane etc. in the appliance. Electrical components might cause leaking gas to ignite. You may identify such sprays by the printed contents or a flame symbol.
- Do not use electrical appliances inside the appliance.
- If you have a lockable appliance, do not keep the key near the appliance or within reach of children.
- The appliance is designed for use in enclosed areas. Do not operate the appliance outdoors or in areas where it is exposed to splash water or damp conditions.
- Special-purpose lamps (incandescent lamps, LEDs, fluorescent tubes) in the appliance serve to illuminate the appliance interior and are not suited for room illumination.

## Climate rating

The appliance is set to operate within specific ambient temperature limits according to its climate rating. These temperature limits should not be exceeded. The correct climate rating for your appliance is indicated on the type plate.

Climate rating	Ambient temperature
SN	+10°C to +32°C
N	+16°C to +32°C
ST	+16°C to +38°C
T	+16°C to +43°C

## Setting up

- Avoid positioning the appliance in direct sunlight or near cookers, radiators and similar sources of heat.
- The floor on which the appliance stands should be horizontal and level. Compensate for uneven floors with the adjustable feet.
- Always ensure that there is good ventilation and that the outward flowing air is able to escape.
- Standard EN 378 specifies that the room in which you install your appliance must have a volume of 1 m<sup>3</sup> per 8 g of R 600a refrigerant used in the appliance, so as to avoid the formation of inflammable gas/air mixtures in the room where the appliance is located in the event of a leak in the refrigerant circuit. The quantity of refrigerant used in your appliance is indicated on the type plate on the inside of the appliance.
- Always install the appliance directly against the wall.

## Dimensions

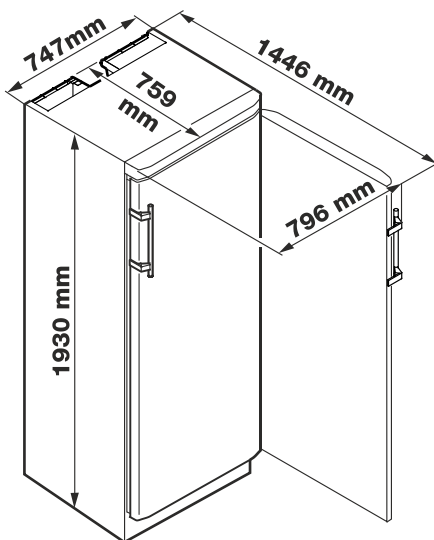

## Electrical connection

Only operate the appliance with **alternating current (AC)**.

The permissible voltage and frequency are indicated on the type plate. The position of the type plate is shown in the description of the appliance.

The socket must be properly earthed and protected by a fuse.

The tripping current of the fuse must be between 10 A and 16 A.

The socket must not be situated behind the appliance and must be easily accessible.

Do not connect the appliance using an extension cable or extension socket.

Do not use stand-alone inverters (conversion of d.c. to a.c./three-phase) or energy saving plugs. Risk of damage to the electronic control system!

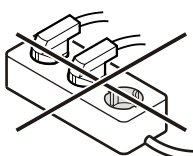

## Operating and control elements

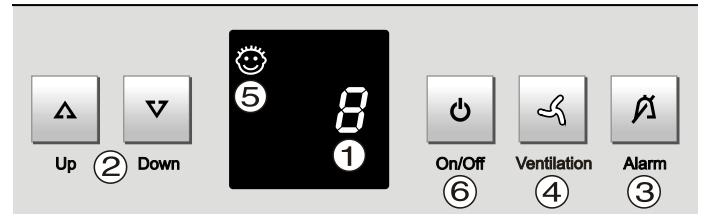

- ① Temperature display
- ② Temperature setting buttons
- ③ Audible warning on/off button
- ④ Fan button
- ⑤ Child lock activated symbol
- ⑥ On/off button

## Switching the appliance on and off

### To switch the appliance on

Press the **On/Off** button until the temperature display lights up.

### To switch the appliance off

Keep the **On/Off** button pressed for approx. 3 seconds so that the temperature display goes out.

## Setting the temperature

### To increase the temperature

Press the **Up** button.

### To reduce the temperature

Press the **Down** button.

- When pressing one of the buttons for the first time, the display will start to flash.
- Pressing this button again enables you to change the temperature setting.
- The electronic controls will switch over automatically about 5 seconds after the last time you pressed the button, and the actual temperature will be displayed.

If **F1** appears in the display, the appliance has suffered a fault. In this case, contact the customer service department.

## Fan

The interior fan ensures a constant and even interior temperature and a suitable climate for wine storage.

When activating the **Ventilation** button, the humidity in the appliance is further increased, which has a particularly positive effect for long-term storage.



Ventilation

The increased level of humidity prevents the corks from drying out.

## Storing wine

If you are storing wine for long periods of time, it should be stored at a temperature of between 10°C and 14°C.

This is the temperature wine cellars are kept at, and it is just right to allow wine to mature properly.

The following drinking temperatures are recommended for the various types of wine.

- Red wines: **+14°C to +18°C**
- Rosé wines: **+10°C to +12°C**
- White wines: **+8°C to +12°C**
- Sparkling wines, Prosecco **+7°C to +9°C**
- Champagne **+5°C to +7°C**

## Audible warning signal

The audible warning signal helps to protect your wines against excessive temperatures.

It sounds when the door has been left open for longer than 60 seconds.

It sounds when the interior gets too warm or too cold. The temperature display will also flash.

The audible warning device is switched off by pressing the **Alarm** button.



The temperature display will continue to flash until the cause of the alarm has been rectified.

## Additional functions

In set-up mode you can set the child-proof lock and adjust the brightness of the display. The child-proof lock is designed to protect the appliance from being switched off accidentally.

### Activating set-up mode:

- Press **Ventilation** button for approx. 5 secs.
- The display shows **c** for child-proof lock.

Note: The value to be altered flashes.

- Select the required function by pressing the **Up/Down** button:

**c** = child-proof lock, **h** = brightness of the display

- Now select/acknowledge the function by pressing the **Ventilation** button briefly:

- > For **c** = **child-proof lock**, press the **Up/Down** button to select

**c1** = child-proof lock **on** or

**c0** = child-proof lock **off** and acknowledge with the **Ventilation** button.

When the symbol ☺ is lit, the child-proof lock is activated.



- > For **h** = **brightness**, press the **Up/Down** button to select

**h1** = minimum to

**h5** = maximum brightness and acknowledge with the **Ventilation** button.

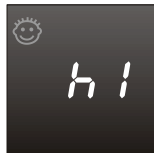

### Exiting set-up mode:

Exit the set-up mode by pressing the **On/Off** button; after 2 min. the electronic system switches over automatically. The normal operating mode is activated again.

## Interior light

**Bulb data:** 15 W (never use a bulb rated at more than 15 W). The voltage should agree with the details on the type plate.  
Socket: E 14.

Replacing the bulb:

**Pull out the mains plug or remove/unscrew the fuse.**

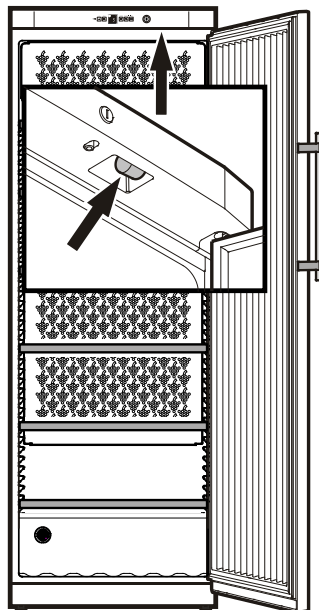

## Air exchange with activated charcoal filter

The way in which wines continue to mature depends on the ambient conditions. The quality of the air is therefore decisive for preserving the wine.

We recommend that you replace the filter once a year. Filters can be obtained from your dealer.

### Changing the filter:

Take the filter by the handle. Turn it 90° to the left or right and remove.

### Inserting the filter:

Insert with the handle in a vertical position. Turn it 90° to the left or right until it clicks into place.

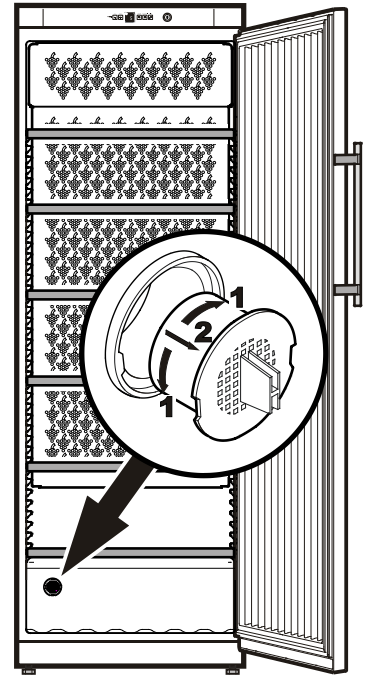

## Safety lock

### Locking the appliance:

- Insert the key as shown by arrow 1.
- Turn the key 90°.

To unlock the appliance, the same procedure must be repeated in the same order.

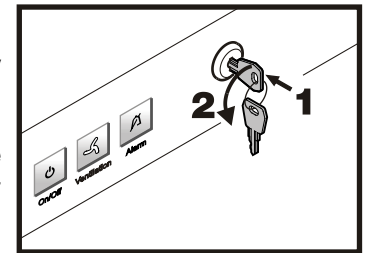

## Cleaning

**Before cleaning always switch off the appliance. Pull out the mains plug or remove/unscrew the fuse.**

- Clean the inside, equipment and outer walls with lukewarm water and a little detergent. Do not use abrasive or acid cleaners or chemical solvents.

**Do not use steam cleaners because of the risk of injury and damage.**

- Ensure that no cleaning water penetrates into the electrical components or ventilation grille.
- The dust should be removed from the refrigeration unit and heat exchanger - metal grid at the back of the appliance - once a year.
- Do not damage or remove the type plate on the inside of the appliance. It is very important for servicing purposes.

## Malfuncions

You may be able to rectify the following faults by checking the possible causes yourself:

- Appliance does not function:
  - Is the appliance switched on?
  - Is the plug correctly fitted in the mains socket?
  - Is the fuse intact?
- Loud running noise:
  - Is the appliance set up firmly on the floor?
  - Does the appliance cause nearby items of furniture or objects to vibrate? Please note that noises caused by the refrigerant circuit cannot be avoided.
- The temperature is not low enough:
  - Is the temperature setting correct (see "Setting the temperature")?
  - Does the separately installed thermometer show the correct reading?
  - Is the ventilation system working properly?
  - Is the appliance set up too close to a heat source?

If none of the above causes apply and you cannot rectify the fault yourself, contact the nearest customer service department stating the type designation ❶, service number ❷ and appliance number ❸ as indicated on the type plate.

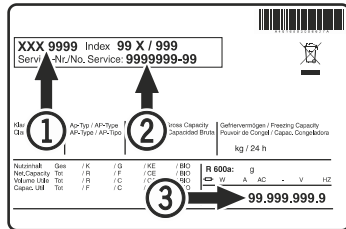

The position of the type plate is shown in the section entitled **Description of the appliance**.

## Shutting your appliance down

If your appliance is to be shut down for any length of time, switch it off and disconnect the plug or switch off or unscrew the fuse. Clean the appliance and leave the door open in order to prevent unpleasant smells.

The appliance complies with the relevant safety regulations and EC Directives 2004/108/EC and 2006/95/EC.

## Changing over door hinges

- 1.** Remove screw from lower hinge bracket.

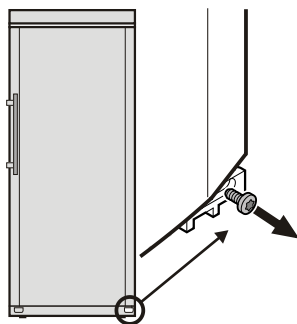

- 2.** Lift door 1, tilt to the right 2 and remove 3.

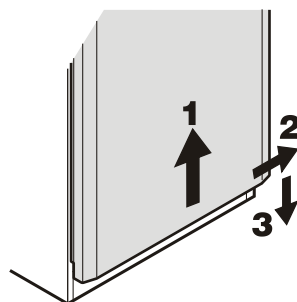

- 3.** Transfer handle to the opposite side.

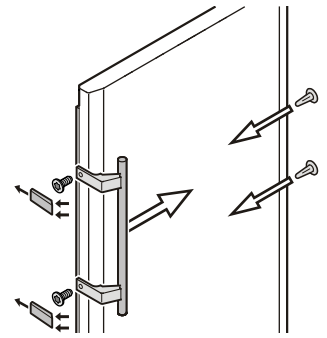

- 4.** Turn lower hinge pin through 90° and remove.

Insert pin on the opposite side and turn through 90°.

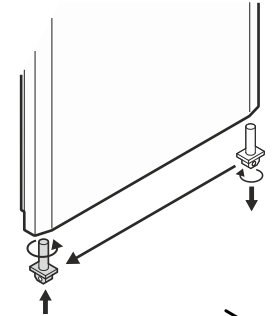

- 5.** Transfer upper hinge components to the opposite side.

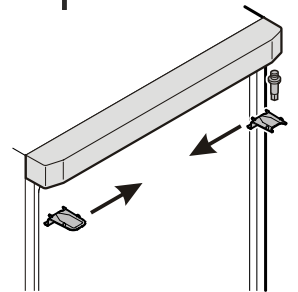

- 6.** Transfer lower hinge bracket to the opposite side.

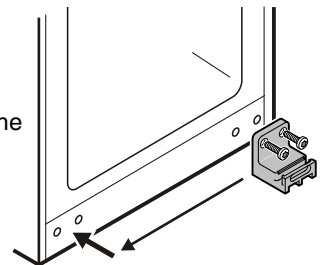

- 7.** Locate door on upper pin.

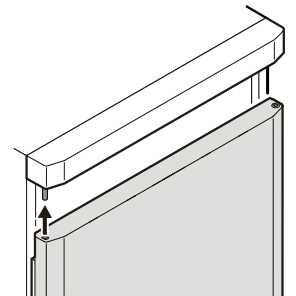

- 8.** Tilt door inwards from the left 1. Secure hinge pin with screw 2.

